

# ZB4BD4

Selector switch head, metal, black, Ø22, 2 positions, spring return from right to left



## Main

Range of product	Harmony XB4
Product or component type	Head for selector switch
Device short name	ZB4
Bezel material	Chromium plated metal
Mounting diameter	22 mm
Head type	Standard
Sale per indivisible quantity	1
Shape of signaling unit head	Round
Type of operator	Right to left spring return
Operator profile	Black standard handle
Operator position information	2 positions 90°

## Complementary

CAD overall width	29 mm
CAD overall height	29 mm
CAD overall depth	44 mm
Net weight	0.045 kg
Resistance to high pressure washer	7000000 Pa at 55 °C, distance : 0.1 m
Mechanical durability	1000000 cycles
Electrical composition code	C3 for <6 contacts using single blocks in front mounting C4 for <6 contacts using single and double blocks in front mounting C5 for <5 contacts using single blocks in front mounting C6 for <5 contacts using single and double blocks in front mounting C7 for <4 contacts using single blocks in front mounting C8 for <4 contacts using single and double blocks in front mounting C11 for <3 contacts using single blocks in front mounting C15 for <1 contacts using single blocks in front mounting
Device presentation	Basic element

Disclaimer: This documentation is not intended as a substitute for and is not to be used for determining suitability or reliability of these products for specific user applications

## Environment

Protective treatment	TH
Ambient air temperature for storage	-40...70 °C
Ambient air temperature for operation	-40...70 °C
Overvoltage category	Class I conforming to IEC 60536
IP degree of protection	IP67 conforming to IEC 60529 IP69 IP69K
NEMA degree of protection	NEMA 13 NEMA 4X
IK degree of protection	IK06 conforming to IEC 50102
Standards	EN/IEC 60947-5-4 EN/IEC 60947-5-5 EN/IEC 60947-1 UL 508 CSA C22.2 No 14 EN/IEC 60947-5-1 JIS C8201-5-1 JIS C8201-1
Product certifications	CSA BV UL listed GL DNV LROS (Lloyds register of shipping) RINA
Vibration resistance	5 gn (f= 2...500 Hz) conforming to IEC 60068-2-6
Shock resistance	30 gn (duration = 18 ms) for half sine wave acceleration conforming to IEC 60068-2-27 50 gn (duration = 11 ms) for half sine wave acceleration conforming to IEC 60068-2-27

## Packing Units

Unit Type of Package 1	PCE
Number of Units in Package 1	1
Package 1 Weight	51 g
Package 1 Height	5 cm
Package 1 width	3.4 cm
Package 1 Length	5.4 cm
Unit Type of Package 2	BB1
Number of Units in Package 2	5
Package 2 Weight	252 g
Package 2 Height	3.3 cm
Package 2 width	5 cm
Package 2 Length	26.5 cm

## Offer Sustainability

Sustainable offer status	Green Premium product
REACH Regulation	<a href="#">REACH Declaration</a>
REACH free of SVHC	Yes
EU RoHS Directive	Pro-active compliance (Product out of EU RoHS legal scope) <a href="#">EU RoHS Declaration</a>
Toxic heavy metal free	Yes
Mercury free	Yes
RoHS exemption information	<a href="#">Yes</a>
China RoHS Regulation	<a href="#">China RoHS declaration</a>
Environmental Disclosure	<a href="#">Product Environmental Profile</a>
Circularity Profile	<a href="#">End of Life Information</a>

## Contractual warranty

---

Warranty	18 months
----------	-----------

---

Dimensions

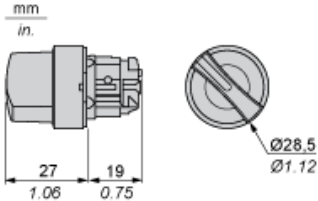

Panel Cut-out for Pushbuttons, Switches and Pilot Lights (Finished Holes, Ready for Installation)

Connection by Screw Clamp Terminals or Plug-in Connectors or on Printed Circuit Board	Connection by Faston Connectors
	
<p>(1) Diameter on finished panel or support                  (2) 40 mm min. / 1.57 in. min.                  (3) 30 mm min. / 1.18 in. min.                  (4) <math>\text{Ø } 22.5 \text{ mm} / 0.89 \text{ in. recommended } (\text{Ø } 22.3 \text{ mm }_0^{+0.4} / 0.88 \text{ in. }_0^{+0.016})</math>                  (5) 45 mm min. / 1.78 in. min.                  (6) 32 mm min. / 1.26 in. min.</p>	



Dimensions in in.

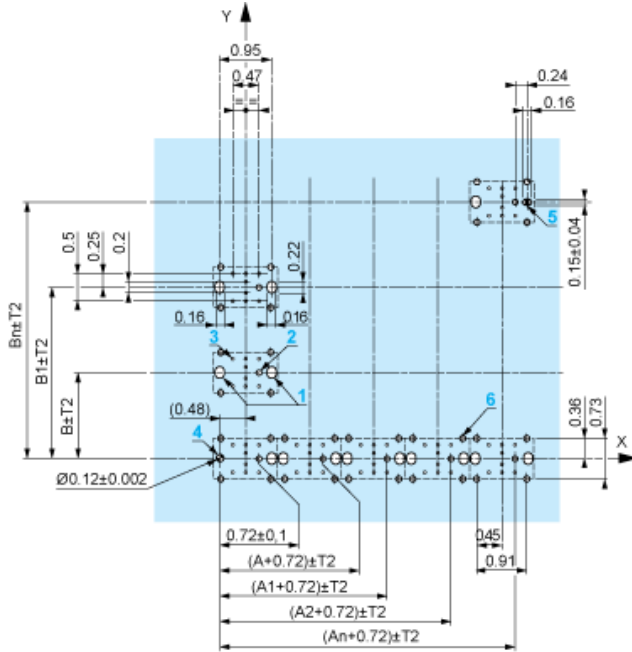

- A: 1.18 in. min.
- B: 1.57 in. min.

### General Tolerances of the Panel and Printed Circuit Board

The cumulative tolerance must not exceed 0.3 mm / 0.012 in:  $T1 + T2 = 0.3 \text{ mm max.}$

### Installation Precautions

- Minimum thickness of circuit board: 1.6 mm / 0.06 in.
- Cut-out diameter: 22.4 mm  $\pm$  0.1 / 0.88 in.  $\pm$  0.004
- Orientation of body/fixing collar ZB4 BZ009:  $\pm 2^\circ 30'$  (excluding cut-outs marked a and b).
- Tightening torque of screws ZBZ 006: 0.6 N.m (5.3 lbf.in) max.
- Allow for one ZB4 BZ079 fixing collar/pillar and its fixing screws:
  - every 90 mm / 3.54 in. horizontally (X), and 120 mm / 4.72 in. vertically (Y).
  - with each selector switch head (ZB4 BD•, ZB4 BJ•, ZB4 BG•).

The fixing centers marked a and b are diagonally opposed and must align with those marked 4 and 5.

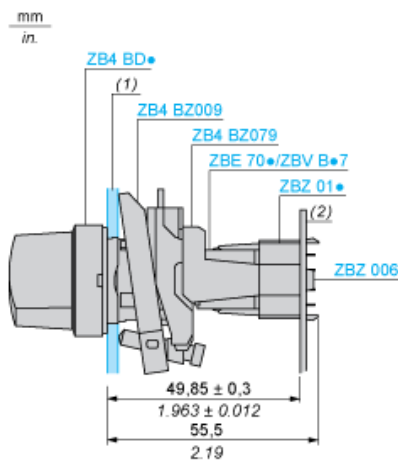

- (1) Panel
- (2) Printed circuit board

## Mounting of Adapter (Socket) ZBZ 01•

- 1 2 elongated holes for ZBZ 006 screw access
- 2 1 hole  $\varnothing$  2.4 mm  $\pm$  0.05 / 0.09 in.  $\pm$  0.002 for centring adapter ZBZ 01•
- 3 8  $\times$   $\varnothing$  1.2 mm / 0.05 in. holes
- 4 1 hole  $\varnothing$  2.9 mm  $\pm$  0.05 / 0.11 in.  $\pm$  0.002, for aligning the printed circuit board (with cut-out marked a)
- 5 1 elongated hole for aligning the printed circuit board (with cut-out marked b)
- 6 4 holes  $\varnothing$  2.4 mm / 0.09 in. for clipping in adapter ZBZ 01•

Dimensions An + 18.1 relate to the  $\varnothing$  2.4 mm  $\pm$  0.05 / 0.09 in.  $\pm$  0.002 holes for centring adapter ZBZ 01•.



---

Electrical Composition Corresponding to Code C3

---



---

Electrical Composition Corresponding to Code C4

---



---

Electrical Composition Corresponding to Code C5

---

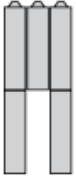

---

Electrical Composition Corresponding to Code C6

---



---

Electrical Composition Corresponding to Code C7

---

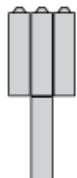

---

Electrical Composition Corresponding to Code C8

---

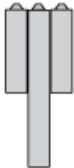

---

Electrical Composition Corresponding to Codes C9, C11, SF1 and SR1

---



---

Electrical Composition Corresponding to Code C15

---

1 N/O

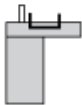

1 N/C

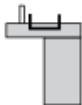

1 N/O + N/C or 1 N/O + N/O or 1 N/C + N/C

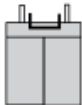



---

Legend

---

Single contact



Double contact



Light block



Possible location



Sequence of Contacts Fitted to 2-position Selector Switch Body

Position 315°



Push	Position	Top			
		Bottom			
	Location		Left	Centre	Right
	State		0	0	0
Contacts	N/O		open	open	open
	N/C		closed	closed	closed

Position 45°



Push	Position	Top			
		Bottom			
	Location		Left	Centre	Right
	State		1	1	1
Contacts	N/O		closed	closed	closed
	N/C		open	open	open