

Part number

MHP 32 L40

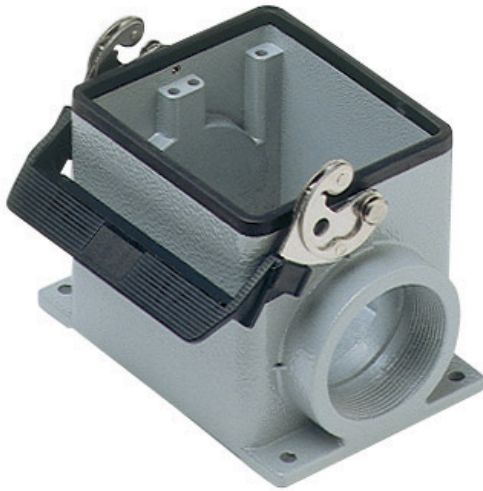

Surface mounting housing, C-TYPE series, with
1 lever, M40 cable entry, size "77.62"



Product description

Product type	Surface mounting housing
Series	C-TYPE
Closing type	With 1 lever
Size	Size "77.62"
Cable entry	M40

Technical data

IP degree of protection	IP65 / IP66 / IP69
--------------------------------	--------------------

Further technical details

Weight	779,00 g
Operating temperature range (min, max)	-40°C...+125°C

Material properties

Colour	RAL 7040 grey
RoHs conformity	Compliant
China RoHs - EFUP	E
REACH SVHC substances	No

Approvals / Standards

Certifications	DNV, BV
UL	ECBT2
cUL	ECBT8

General ordering information

EAN13 code	8015747054935
eCl@ss 8.1	27440202
ETIM 7.0	EC000437

Packaging Information

Packaging length	475,00 mm
Packaging height	200,00 mm
Packaging width	150,00 mm
Packaging weight	3,63 kg
Packaging volume	14,25 dm ³
Packaging description	Carton box
Packaging quantity	4 Pcs
Packaging EAN code	8015747178051
Sub-packaging length	116,00 mm
Sub-packaging height	113,00 mm
Sub-packaging width	142,00 mm
Sub-packaging weight	0,91 kg
Sub-packaging volume	1,86 dm ³
Sub-packaging description	Carton box
Sub-packaging quantity	1 Pcs
Sub-packaging EAN barcode	8015747054959

Part number

MHP 32 L40



Catalogue drawings

CHP L CAP L - MHP L MAP L

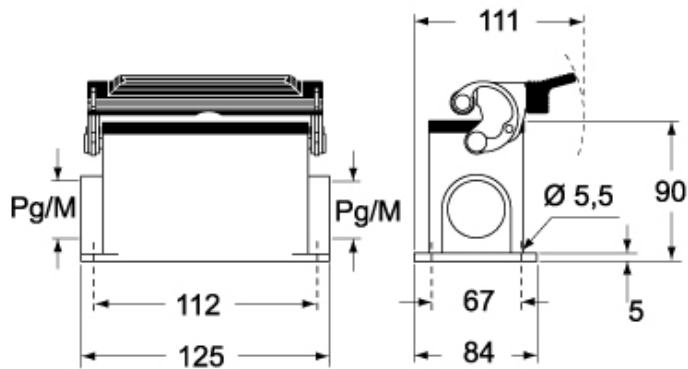

CHP LS CAP LS - MHP LS MAP LS

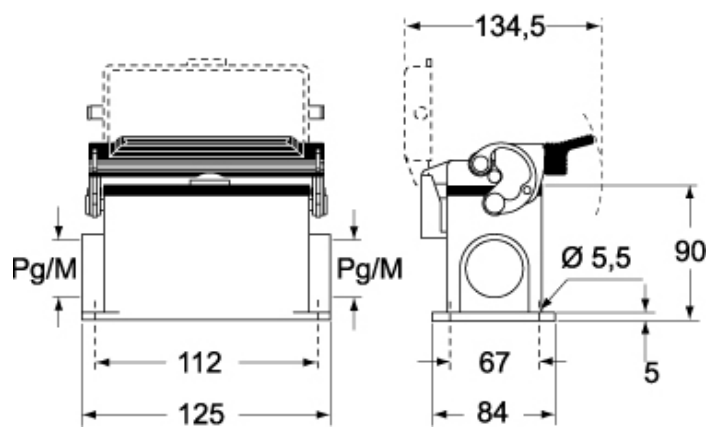

Notes

Dimensions shown in mm are not binding and may be changed without notice.