

## VALCO - STANDARD LEVEL FLOAT SWITCH - S1 SERIES

00.0002.2842

200mm length, Brass/ABS, G1, NC, DIN, Max 20 bar

- 100 to 500 mm. length (step 50 mm.)
- Brass stem and connection, Spansil float
- Max working pressure up to 20 bar
- Max temperature 105°C
- Integrated temperature switch (on request)



### Product description

Level controls with 1 electrical contact, reliable, compact and easy to install. Designed to offer a range of level switches to meet the request for a cheap monitoring of the level in small tanks. Rugged construction and low maintenance.

### Specifications

<b>Current</b>	0.5A/0.7A
<b>Electrical connection</b>	DIN A 43650
<b>Function</b>	N/O & N/C
<b>IP Class</b>	IP65
<b>Length</b>	200
<b>Manufacturer Part No</b>	S1.B45.3.0200.O.25GO.S1.L.1.I2
<b>Material of connection</b>	Brass
<b>Material of float</b>	SPANSIL
<b>Material of seals</b>	NBR
<b>Max. pressure</b>	20
<b>Mounting</b>	Vertical
<b>Process connection</b>	G1
<b>Specific gravity</b>	0.35
<b>Temperature range to</b>	105

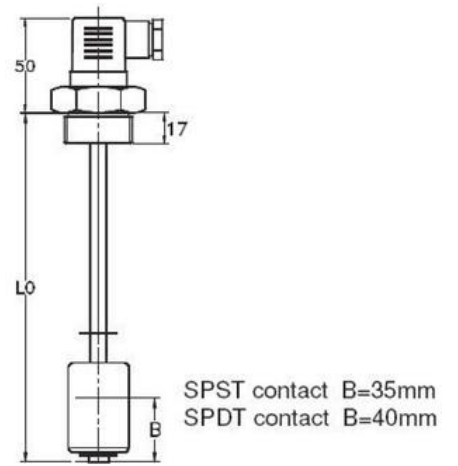
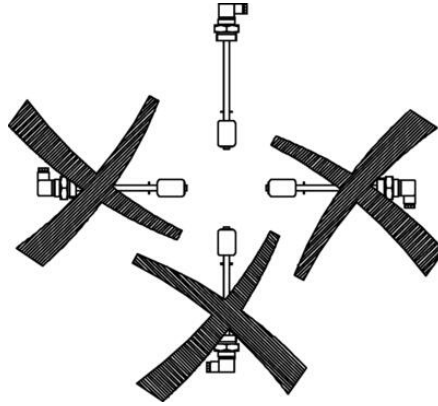
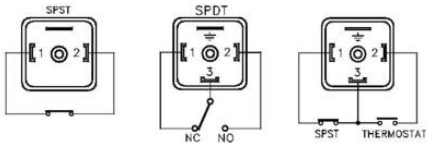

Pipe lengths L0	0100	0150	0200	0250	0300	0350	0400	0450	0500
Length in mm	100	150	200	250	300	350	400	450	500

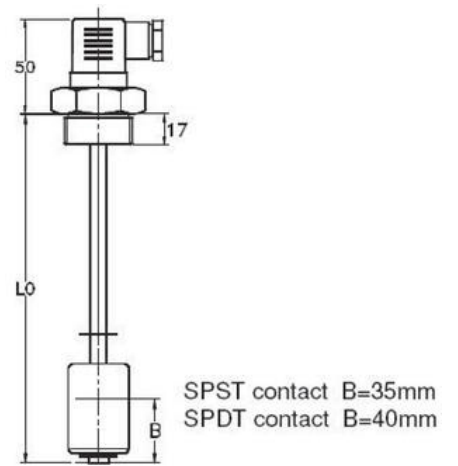
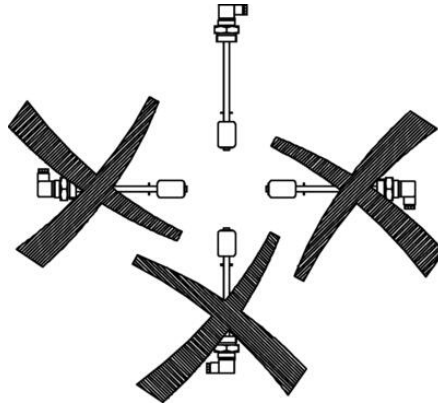
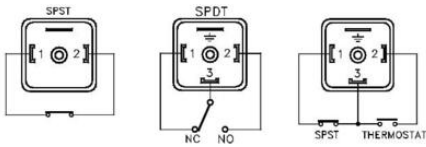

Pipe lengths L0	0100	0150	0200	0250	0300	0350	0400	0450	0500
Length in mm	100	150	200	250	300	350	400	450	500